

# PURe<sup>®</sup>

WINDOW SYSTEMS

even the best ideas can be improved

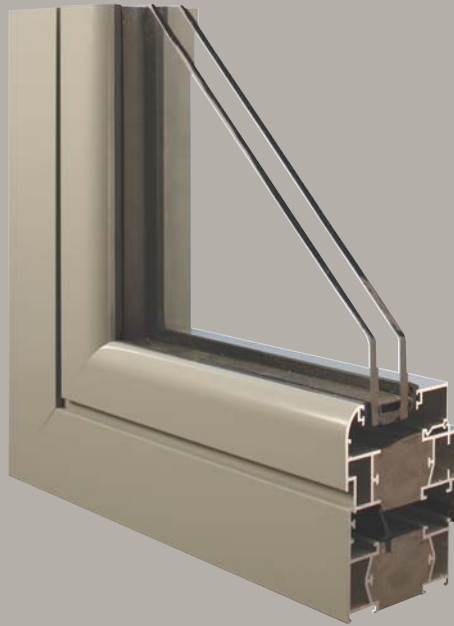

SENIOR ARCHITECTURAL SYSTEMS

Ultra-low\*  
U-value  
0.71 W/m<sup>2</sup>K

Generic Green  
Guide Rating  
A



## contents

---

- 04 embracing simplicity
- 06 developed to perform
- 08 thermal values
- 10 the Senior difference
- 12 the environment
- 14 BREEAM®



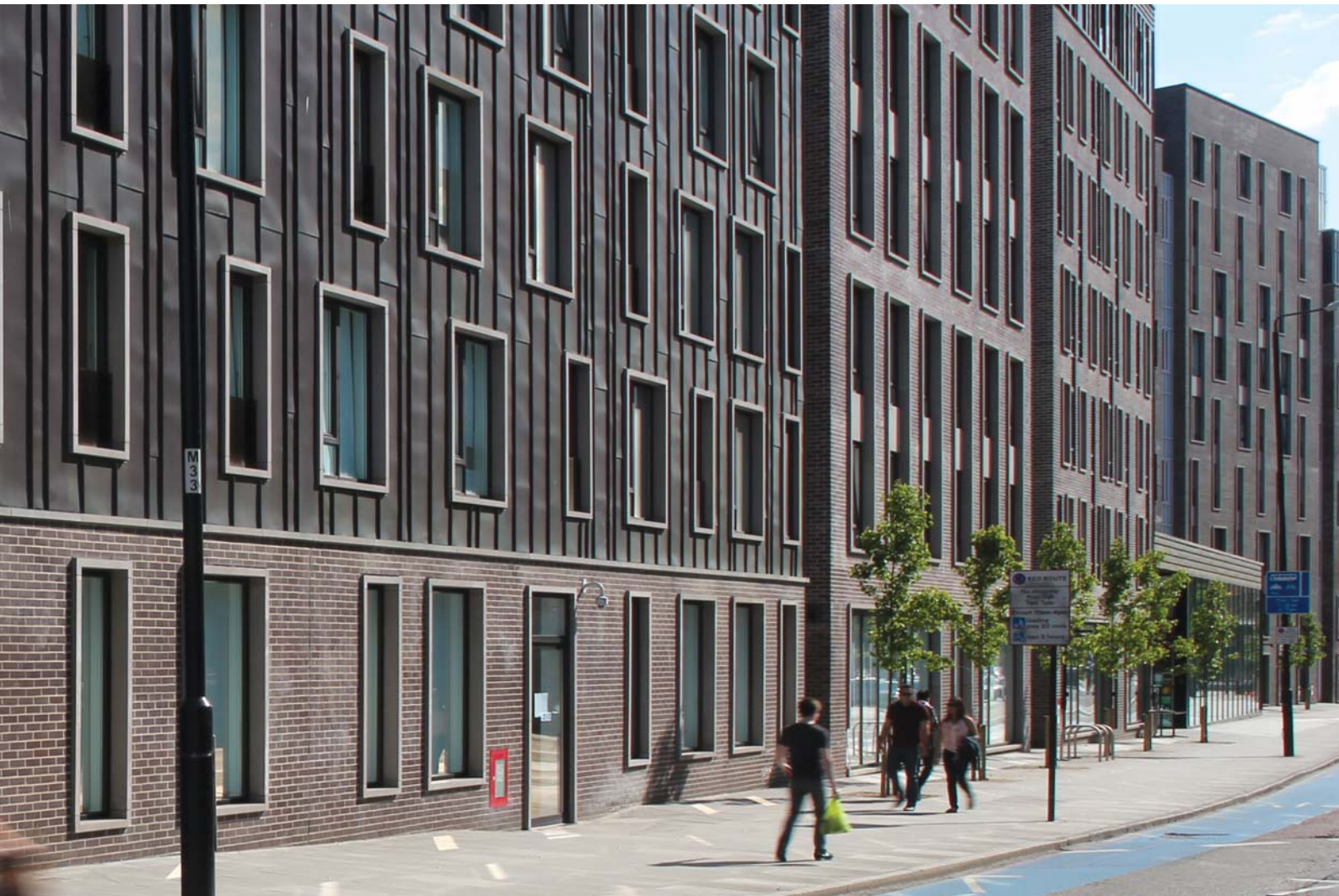

even the best  
ideas can be  
improved

The PURe® window range\* has been developed by Senior Architectural Systems, one of the largest and most respected fenestration companies in the UK today. The system is the next generation of evolved products, to exceed current and meet future legislation.

Senior is constantly looking for new and innovative products, processes and service enhancements that will enable your next project to stand out from the crowd and make our world a better place.



# embracing simplicity

The PRe® range\* is an aluminium window system that incorporates high insulation polyurethane foam (PUR) as an innovative thermal barrier.

Already used for many years in the construction industry to provide insulation, PUR is fully recyclable, safe to handle and gives ultra-high thermal performance.

Its ground-breaking use as a thermal barrier in windows is set to revolutionise the market, giving U-values as low as 0.71 W/m<sup>2</sup>K when calculated as a commercial CEN standard window.

Easy to manufacture using existing tooling, the PRe® window range is the new, simple way to exceed current and meet future building regulations.



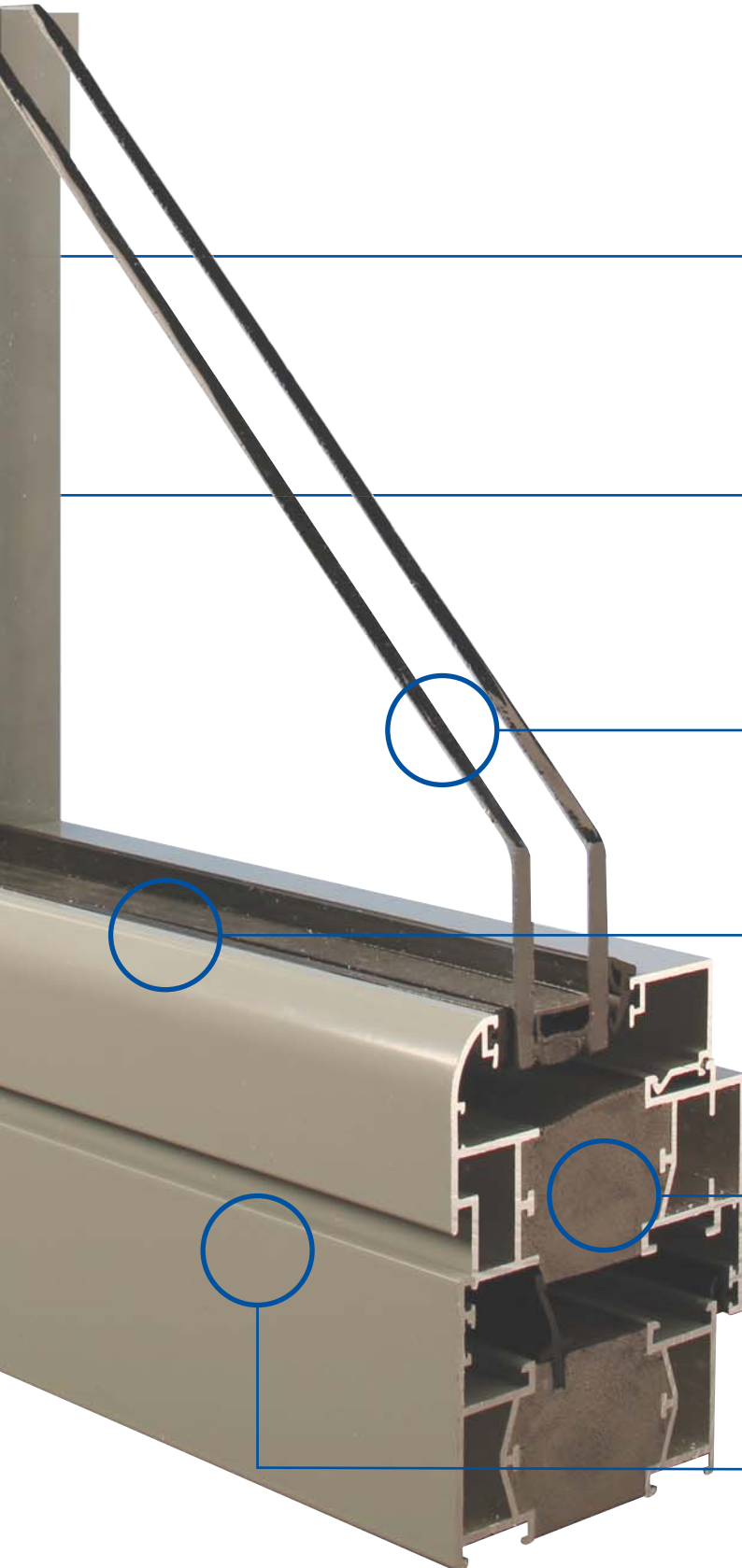

The PURe® range is safe to handle and manufacture and benefits from extensive warranties, with an in service lifecycle in excess of 40 years.

The range has been designed to exceed current and meet future building regulations, and is simple to manufacture, using existing tooling.

Double or triple glazing options available, up to 50mm to maximise thermal and acoustic performance, via our glazing division: Senior Glass Systems, giving assured quality and lead-times.

Powder coated (single or dual colour) aluminium externally and internally.

Expanded polyurethane, tried and tested for many years and used in the construction industry, typically in cladding and insulation products and fully recyclable.

Environmentally focused. Aluminium is a cradle-to-cradle product and can be recycled endlessly.



# developed to perform



From concept to design through to manufacturing, the PRe® window range has been developed with simplicity and performance in mind.

The innovative use of expanded polyurethane foam as a thermal barrier gives the range its impressive thermal performance, ensuring it exceeds current and meets future legislation.

With the capacity to evolve further, the PRe® window range is a next generation product that will benefit your projects both now and in the future.



Ultra low  
u-value\*

**0.71**  
W/m<sup>2</sup>K

Designed  
to meet

**Passiv  
haus**  
Standard

Generic  
Green Guide

**A**  
Commercial

In Service  
Lifecycle

**40**  
Years +

Glazing

**Double  
Triple**

Recyclable

**Cradle  
- to -  
Cradle**

\*CEN Standard commercial windows

Weather Rating  
BS 6375 Part 1: 2009  
Tilt & Turn

Air Permeability	600 Pa
Water Tightness	600 Pa
Wind Resistance	2400 Pa

Top Hung Casement

Air Permeability	600 Pa
Water Tightness	600 Pa
Wind Resistance	2400 Pa

Side Hung Casement

Air Permeability	600 Pa
Water Tightness	600 Pa
Wind Resistance	2400 Pa

Performance  
BS 6375 Part 2: 2009

Top Hung Casement	Pass
Side Hung Casement	Pass
Tilt / Turn	Pass

Security

All types security tested to PAS 24: 2012 and BS6375
--



# thermal values

Our experience in developing innovative, thermally efficient windows goes back to 1991, when Senior Architectural Systems was founded.

The company was started with the aim of revolutionising the UK fenestration industry.

And that's just what we've done.

From the first of our window systems, the SW400 suite, through to the latest, our PRe® range, we are constantly looking for new and innovative products, processes and service enhancements that will enable us to stand out from the crowd and make your world a better place.

The charts on the right showcase the advancements in thermal performance that each product development has achieved.





### Product development / Thermal Values / Commercial CEN standard

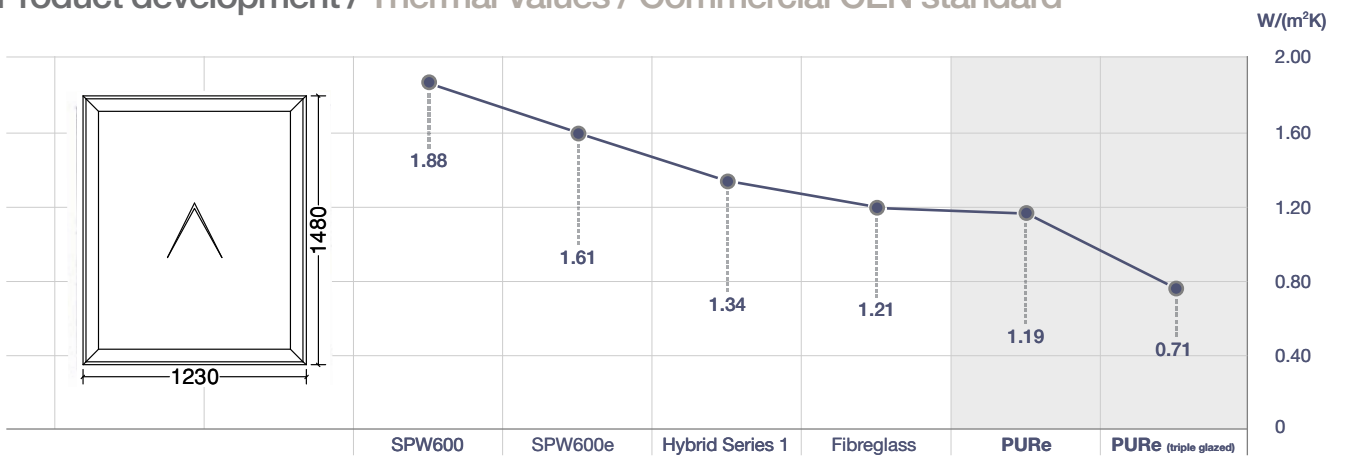

### Product development / Thermal Values / Domestic CEN standard

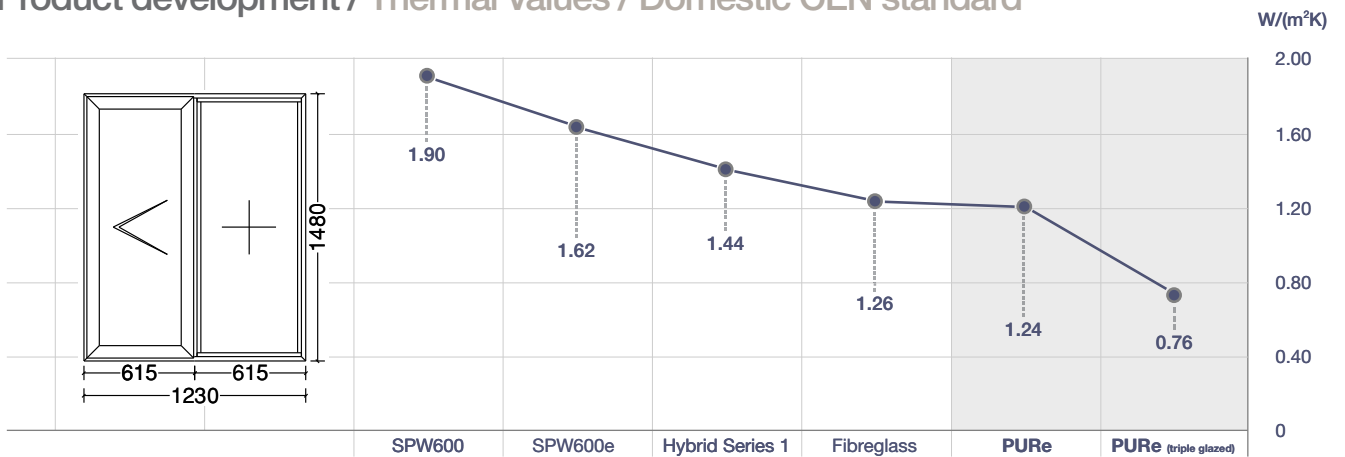

# the Senior difference

Senior prides itself on providing a responsive and personal customer service with local availability, and on forming long term, mutually profitable relationships with specifiers and fabricators.

## **Quick Facts**

**British based company:** all our systems and products are fabricated and supplied from within the United Kingdom.

**Fully accredited systems** which enhance any building façade.

**All products are manufactured/fabricated** to exacting standards and quality is assured through constantly monitored systems and processes.

**All material processing is carried out 'in-house'** leading to a highly efficient and time sensitive turnaround service.

**Full range of products** utilising differing materials.

**Expert technical and specification support** available.

**Consideration is always given** to materials used in terms of recyclability and sustainability.

**Dedicated ISO 14001, ISO 18001 and ISO 9001** quality accredited service centres in England, Wales and Scotland.

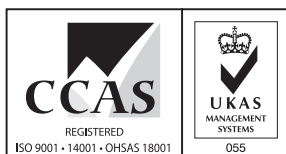

1996/026





# taking the environment seriously

We are aware of the impact that buildings have on the environment, and we take a lifecycle responsibility for the products that we manufacture and deliver.

We minimise the risk of any chemical releases during manufacturing, and our systems in aluminium and wood are perfect for producing low maintenance, energy efficient windows and façades that have a long life.

Our metal of choice is aluminium. It recycles perfectly without losing any of its properties. And best of all for our planet, we make sure that our suppliers of wood always plant more trees than we use.

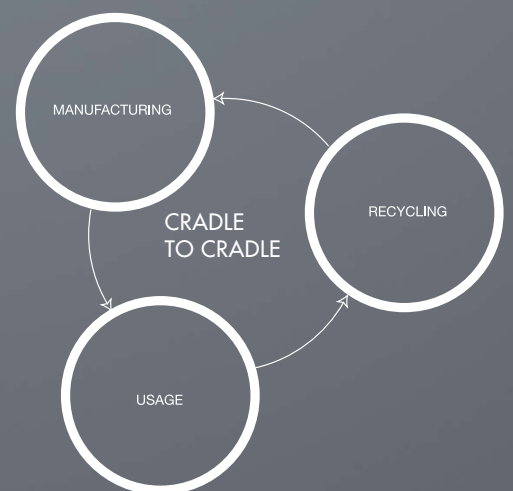



# helping you achieve **BREEAM<sup>®</sup> credits**

## What is BREEAM?

BREEAM (Building Research Establishment's Environmental Assessment Method) is the world's foremost environmental assessment method and rating system for buildings, with 250,000 buildings with certified BREEAM assessment ratings and over a million registered for assessment since it was first launched in 1990. The system sets the standard for best practice in sustainable building design, construction and operation.

## Ten categories for a sustainable building

A BREEAM assessment uses recognised measures of performance, set against established benchmarks, to evaluate a building's specification, design, construction and use.

Credits are awarded across ten categories based on the outcomes of the building assessed. The credits are then combined to provide a single score, achieving either a Pass, Good, Very Good, Excellent or Outstanding overall BREEAM rating.

## Senior and BREEAM

Senior Architectural Systems product range has been developed with BREEAM at its centre. Our systems are proven to help you achieve a credible BREEAM rating. With many BREEAM rated projects already successfully utilising Senior products, we have a wealth of experience to assist the architect/designer in meeting their sustainability goals.



**Management**  
**Health & Well-Being**  
**Energy**  
**Transport**  
**Water**  
**Materials**  
**Waste**  
**Land Use & Ecology**  
 Pollution  
 Innovation

Categories	Credits Available	Senior Architectural products impact
Management	11	No
Health & Well-Being	14	Yes
Energy	24	Yes
Transport	9	No
Water	9	No
Materials	13	Yes
Waste	7	Yes
Land Use & Ecology	10	No
Pollution	12	No
Innovation	10	Yes
<b>Total</b>	<b>119</b>	

## HEAD OFFICE

Senior Architectural Systems Ltd, Eland Road, Denaby Main, Doncaster, South Yorkshire, DN12 4HA.  
Tel: 01709 772 600. Fax: 01709 772 601. E-mail: [info@sasmail.co.uk](mailto:info@sasmail.co.uk)

## BRANCHES

Scotland; Unit 4 Dunlop Court, Deans Industrial Estate SW, Livingston, West Lothian, EH54 8SL.  
Tel: 01506 407 640. Fax: 01506 407 641.

South; Unit 4 Leeway Industrial Estate, Newport, South Wales, NP19 4SL.  
Tel: 01633 277 880. Fax: 01633 277 121.

Senior Glass Systems Ltd, Lakeside House, Hopper Hill Road, Eastfield, Scarborough, YO11 3YS.  
Tel: 01723 580 010. Fax: 01723 580 018. E-mail: [sgenquiries@sasmail.co.uk](mailto:sgenquiries@sasmail.co.uk)

Visit our showroom at the Building Centre; Ground level, L4, Store Street, London, WC1E 7BT.

[www.seniorarchitectural.co.uk](http://www.seniorarchitectural.co.uk)



Enhanced Security Door  
Enhanced Security Window  
Window General Performance



ALUMINIUM

HYBRID

GLASS



SENIOR ARCHITECTURAL SYSTEMS

Senior Architectural Systems is a major UK supplier of fenestration solutions, specialising in providing aluminium, timber and glass glazing systems to the highest standards. This brochure is intended to show what makes Senior's unique and how our products and services can make a difference to customers, clients, their projects and the environment.

Whilst every effort has been made to ensure the accuracy of this publication, no responsibility for content is taken by Senior Architectural Systems Ltd. We strongly recommend the specification for any given application is checked with Senior Architectural Systems before an order is placed. Senior Architectural Systems reserves the right to alter any of the specifications given in this publication without prior notice due to a process of continual development.